

Compact Disc Changer SL-MC410

Operating Instructions

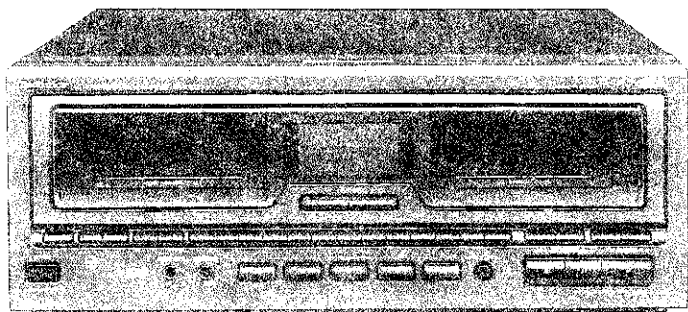

Note:
The "EB" indication shown on the packing case indicates United Kingdom.

COMPACT
disc
DIGITAL AUDIO

Technics®

Before connecting, operating or adjusting this product, please read these instructions carefully. Please save this manual.

EB GN GC

RQT3781-1B

Dear Customer

Thank you for purchasing this Technics product. For optimum performance and safety, please read these instructions carefully.

CAUTION:

The AC voltage is different according to the area.
Be sure to set the proper voltage in your area before use.
(For details, please refer to the page 5.)

Table of contents

Caution for AC mains lead (For United Kingdom).....	3
Suggestions for safety.....	4
Connections.....	5
Supplied accessories.....	6
Concerning the liner notes organizer.....	6
Preparing for the remote control.....	7
Setting/Removing discs.....	8
Front panel controls.....	9
<hr/>	
Basic operations.....	10
Single disc play.....	12
ID scan function.....	12
Disc grouping play.....	13
Program play.....	16
Direct programming.....	18
Random play.....	19
Repeat function.....	20
Search function.....	20
Skip function.....	21
CD-TEXT function.....	22
Time mode selection.....	25
<hr/>	
Quick reference table for remote control operation.....	26
<hr/>	
Concerning compact discs.....	29
Troubleshooting guide.....	30
Product service.....	31
Technical specifications.....	31
Disc index.....	Back cover

Safety regulation

CAUTION!

THIS PRODUCT UTILIZES A LASER.
USE OF CONTROLS OR ADJUSTMENTS OR PERFORMANCE OF PROCEDURES OTHER THAN THOSE SPECIFIED HEREIN MAY RESULT IN HAZARDOUS RADIATION EXPOSURE.
DO NOT OPEN COVERS AND DO NOT REPAIR YOURSELF. REFER SERVICING TO QUALIFIED PERSONNEL.

CAUTION!

DO NOT INSTALL OR PLACE THIS UNIT IN A BOOKCASE, BUILT IN CABINET OR IN ANOTHER CONFINED SPACE IN ORDER TO KEEP WELL VENTILATED CONDITION. ENSURE THAT CURTAINS AND ANY OTHER MATERIALS DO NOT OBSTRUCT THE VENTILATION CONDITION TO PREVENT RISK OF ELECTRIC SHOCK OR FIRE HAZARD DUE TO OVERHEATING.

DANGER	INVISIBLE LASER RADIATION WHEN OPEN. AVOID DIRECT EXPOSURE TO BEAM.
ADVARSEL	USYNLIG LASERSTRÅLING VED ÅBNING. NÅR SIKKERHEDSÅBRYDERE ER UDE AF FUNKTION. UNDSÅ UDSÆTTELSE FOR STRÅLING.
VARO!	AVATTAESSA JA SUOJALUKITUS OHITETTAESSA OLET ALTIINA NÄKYMÄTÖNTÄ LASERSÄTELYLLE. ÄLÄ KATSO SÄTEESSEEN.
VARNING	OSYNLIG LASERSTRÅLNING NÄR DENNA DEL ÄR ÖPPNAD OCH SPÄRREN ÄR URKOPPLAD. BETRÄKTA EJ STRÅLEN.
ADVARSEL	USYNLIG LASERSTRÅLING NÄR DEKSEL ÅPNES OG SIKKERHEDSLÅS BRYTES. UNNGÅ EKSPONERING FOR STRÅLEN.
VORSICHT	UNSICHTBARE LASERSTRALUNG. WENN ABDECKUNG GEÖFFNET, NICHT DEM STRAHLEN AUSSETZEN.

(Inside of product)

(Indersiden af apparatet)

(Tuotteen sisällä)

(Apparatens insida)

(Produktets innsida)

(Im Inneren des Gerätes)



(Back of product)

Caution for AC mains lead



(For United Kingdom)
("EB" area code model only)

For your safety, please read the following text carefully.

This appliance is supplied with a moulded three pin mains plug for your safety and convenience.

A 5-ampere fuse is fitted in this plug.

Should the fuse need to be replaced please ensure that the replacement fuse has a rating of 5-ampere and that it is approved by ASTA or BSI to BS 1362.

Check for the ASTA mark  or the BSI mark  on the body of the fuse.

If the plug contains a removable fuse cover you must ensure that it is refitted when the fuse is replaced.

If you lose the fuse cover the plug must not be used until a replacement cover is obtained.

A replacement fuse cover can be purchased from your local dealer.

CAUTION!

IF THE FITTED MOULDED PLUG IS UNSUITABLE FOR THE SOCKET OUTLET IN YOUR HOME THEN THE FUSE SHOULD BE REMOVED AND THE PLUG CUT OFF AND DISPOSED OF SAFELY.

THERE IS A DANGER OF SEVERE ELECTRICAL SHOCK IF THE CUT OFF PLUG IS INSERTED INTO ANY 13-AMPERE SOCKET.

If a new plug is to be fitted please observe the wiring code as shown below.

If in any doubt please consult a qualified electrician.

IMPORTANT

The wires in this mains lead are coloured in accordance with the following code:

Blue: Neutral, Brown: Live.

As these colours may not correspond with the coloured markings identifying the terminals in your plug, proceed as follows:

The wire which is coloured Blue must be connected to the terminal which is marked with the letter N or coloured Black or Blue.

The wire which is coloured Brown must be connected to the terminal which is marked with the letter L or coloured Brown or Red.

WARNING: DO NOT CONNECT EITHER WIRE TO THE EARTH TERMINAL WHICH IS MARKED WITH THE LETTER E, BY THE EARTH SYMBOL  OR COLOURED GREEN OR GREEN/YELLOW.

THIS PLUG IS NOT WATERPROOF-KEEP DRY.

Before use

Remove the connector cover.

How to replace the fuse

The location of the fuse differ according to the type of AC mains plug (figures A and B). Confirm the AC mains plug fitted and follow the instruction below. Illustrations may differ from actual AC mains plug.

1. Open the fuse cover with a screwdriver.

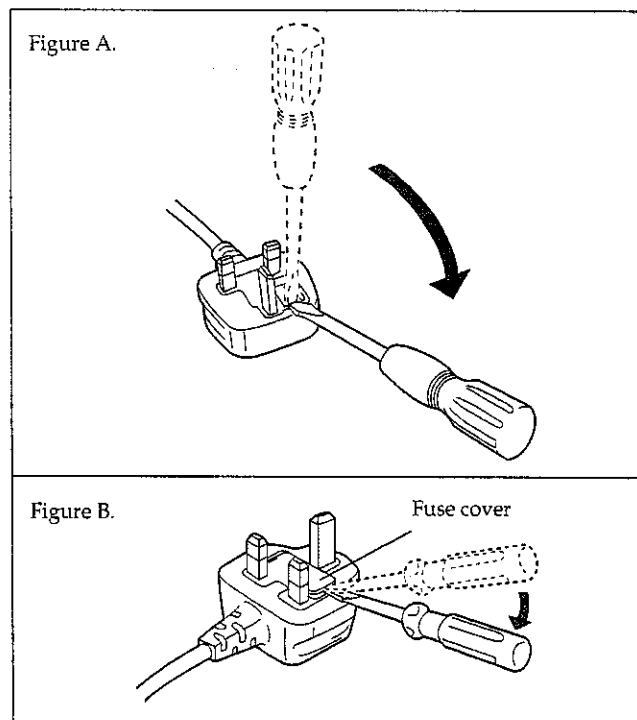

2. Replace the fuse and close or attach the fuse cover.

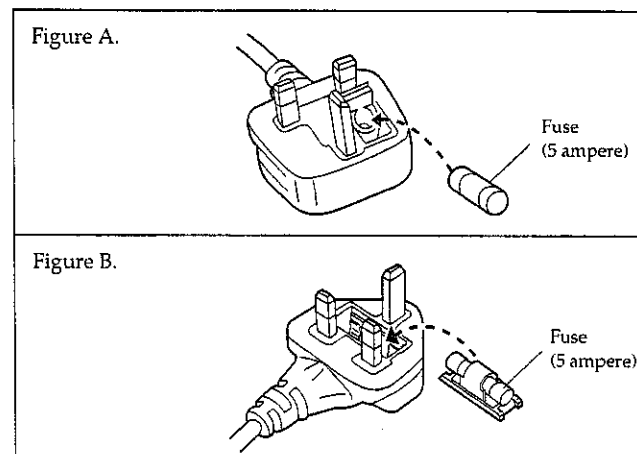

Suggestions for safety

Placement

Avoid placing the unit in areas of:

- direct sunlight
- high temperature
- high humidity
- excessive vibration
- uneven surfaces (Place the unit on a flat level surface.)

Such conditions might damage the cabinet and/or other component parts and thereby shorten the unit's service life.

Stacking

Never place heavy items on top of the unit or the AC power cord.

Voltage

- It is very dangerous to use an AC power source of high voltage such as for an air conditioner.
A fire might be caused by such a connection.
- A DC power source can not be used.
Be sure to check the power source carefully, especially if on a ship or other place where DC is used.

Power cord protection

- Avoid cuts, scratches or poor connection of the AC power cord, as this may result in fire or electric shock.
Excessive bending, pulling or slicing of the cord should also be avoided.
- Do not pull on the cord when you are disconnecting the power, as this could cause an electric shock. Grasp the plug firmly when you disconnect the power supply.
- Never touch the plug with wet hands or a serious electric shock could result.

Foreign materials

- Ensure that no foreign objects, such as needles, coins, screwdrivers etc., accidentally fall into the unit.
Otherwise, a serious electric shock or malfunction could occur.
- Be extremely careful about spilling water or liquid on/into the unit, as a fire or electric shock could occur.
(Disconnect the power plug and contact your dealer immediately if this occurs.)
- Avoid spraying insecticides onto the unit as they contain flammable gases which can be ignited.
- Insecticides, alcohol, paint thinner and similar chemicals should never be used to clean the unit as they can cause flaking or cloudiness to the cabinet finish.

Service

- Never attempt to repair, disassemble or reconstruct the unit if there seems to be a problem.
A serious electric shock could result if you ignore this precautionary measure.
- If a problem occurs during operation (the sound is interrupted, indicators fail to light up, smoke is detected, etc.) contact your dealer or Authorized Service Center immediately.
- Disconnect the power supply if the unit will not be used for a long time. Otherwise the operation life could be shortened.

Cautions on moving this unit

Before moving the changer to another location, be sure to remove all discs from the slots and turn off the changer.

Failure to do so will expose the compact discs and the changer to the risk of severe damage.

CAUTION

The changer mechanism automatically locks when power is turned off, to protect it against damage in transport. Therefore, always press POWER and make sure "OFF" appears on the display before you unplug the changer.

Other cautions

Outside light or noise may sometimes cause the changer to detect a disc when there isn't one. However, the changer always correctly detects the disc when in the play mode no matter what.



Do not leave the front panel open. Infiltrating dust or other matter may lead to damage or malfunctions.

Connections

Note:

- Set the changer on a flat, level surface.
- Before connecting the changer to your audio system, make sure that the power of the changer and all other system components is turned off.
- **(For areas except United Kingdom, Australia and N.Z.)**
Make sure the voltage selector is set to the correct position.

Stereo connection cable

White (L) 
Red (R) 

(For United Kingdom only)

BE SURE TO READ THE CAUTION FOR THE AC MAINS LEAD ON PAGE 3 BEFORE THE FOLLOWING CONNECTIONS.

Before use

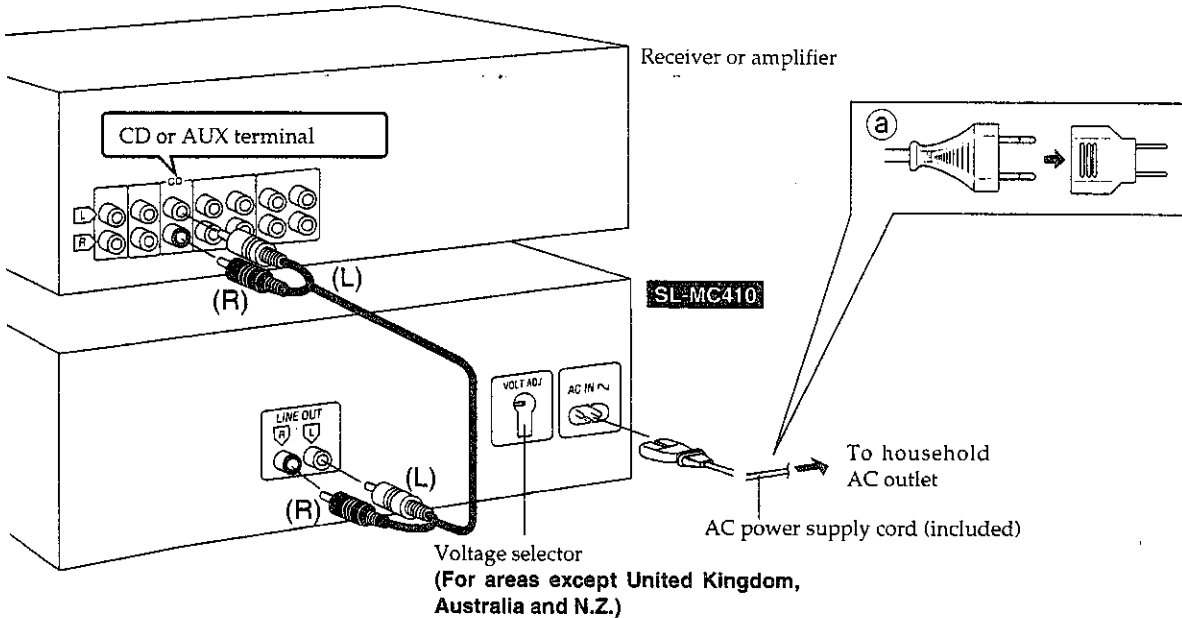

(For areas except United Kingdom, Australia and N.Z.)

CAUTION:

Use a minus (-) screwdriver to set the voltage selector to the voltage setting for the area in which the unit will be used. (If the power supply in your area is 115 V or 120 V, please set the voltage selector as follows:

- For 115 V: set to 110 V
- For 120 V: set to 127 V)

Note that this unit will be seriously damaged if this setting is not made correctly.

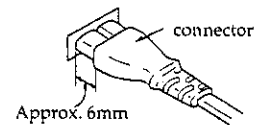

(For areas except United Kingdom, Australia and N.Z.)

Insertion of Connector:

Even when the connector is perfectly inserted, depending on the type of inlet used, the front part of the connector may jut out as shown in the drawing. However there is no problem using the unit.

a

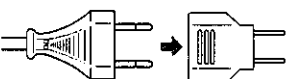

(For areas except United Kingdom, Australia and N.Z.)

If the power plug will not fit your socket, use the power plug adaptor (included).

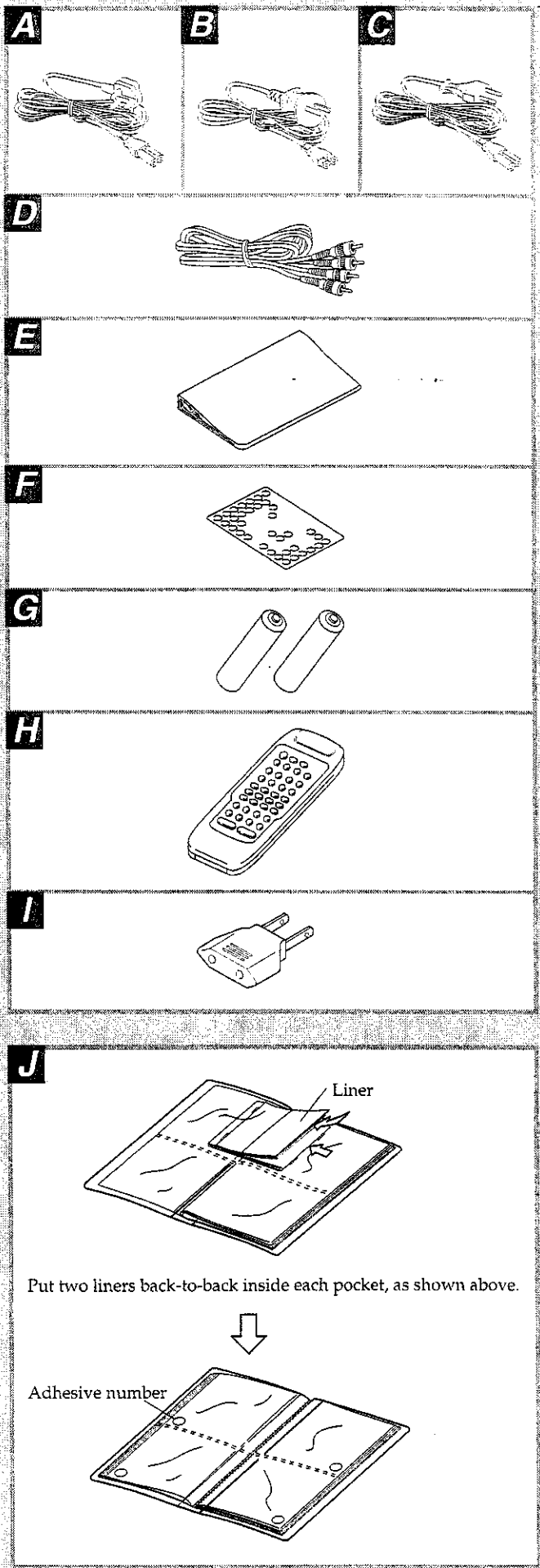

Supplied accessories

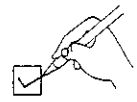

Please check and identify the supplied accessories.

- A** (For United Kingdom)
AC mains lead (RJA0049-K) 1
- B** (For Australia and N.Z.)
AC power supply cord (RJA0036-K) 1
- C** (For others)
AC power supply cord (RJA0019-2K) 1
- D** Stereo connection cable (SJP2249-3) 1
- E** Notebook-like binder [Liner notes organizer]
(RFA0623-K1) 1
- F** Adhesive numbers (RQLA0326) 1
- G** Batteries 2
- H** Remote control transmitter (EUR644972) 1
- I** (For except United Kingdom, Australia and N.Z.)
Power plug adaptor (SJP5213-2) 1

Use numbers indicated in parentheses when asking for replacement parts.

Concerning the liner notes organizer

Your changer comes with a notebook-like binder (liner notes organizer) in which you can keep your CD liners. There are also adhesive numbers for indicating slot numbers in the binder. This is a convenient way to keep track of what disc is in what slot.

Put two liners back-to-back inside each pocket, as shown above.

Adhesive number

Preparing for the remote control

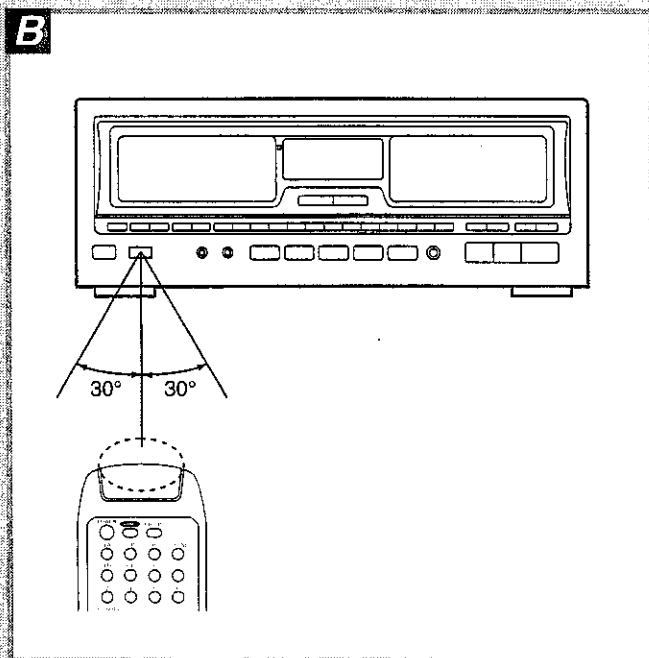
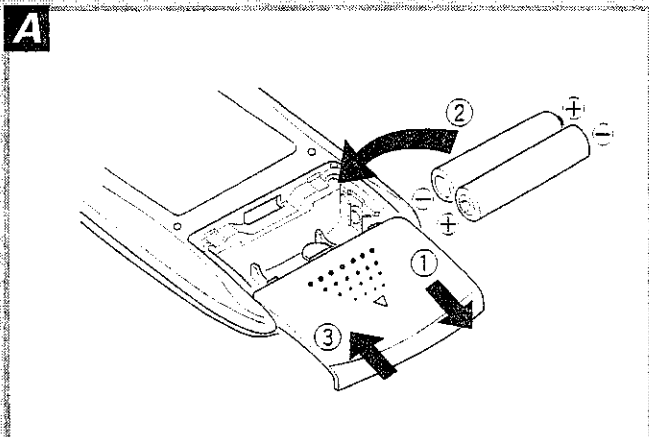

Battery installation

Check the (+) and (-) sides.

Use of batteries

- Do not mix old and new batteries, or batteries of different types (carbon and alkaline, etc.).
- Never subject batteries to excessive heat or flame; do not attempt to disassemble them; and be sure they are not short-circuited.
- If the remote control is not to be used for a long period of time, remove the batteries and store them in a cool, dark place.
- Do not attempt to recharge alkaline or carbon batteries.
- Do not use rechargeable type batteries.

Battery life

Battery life is about one year.

The batteries should be replaced if the receiver fails to respond to commands from the remote control transmitter even when held close to the remote control signal sensor.

When you need to replace these batteries

Use two R03/LR03,AAA,UM-4 or equivalent batteries.

Correct method of use

Use the remote control within 60 degrees and within 7 meters facing toward the unit.

Operation notes

- Aim the remote control's transmission window toward the unit's sensor. Avoid any obstacles.
- Be sure the transmission window and the unit's sensor are free from dust. Excessive dust might affect performance.
- Do not expose the remote control signal sensor to direct sunlight or to the bright light of an inverter fluorescent light.

A

1

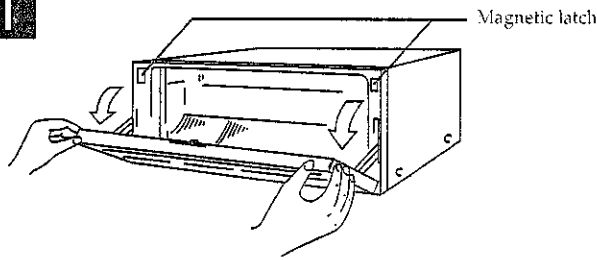

2

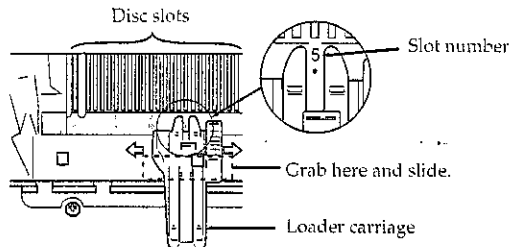

3

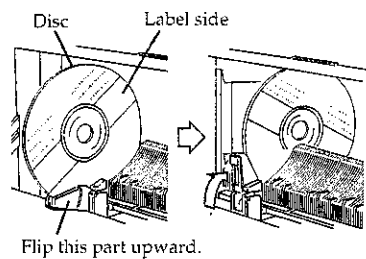

4

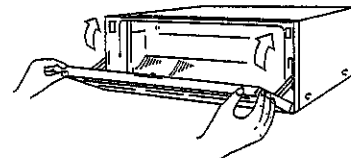

B

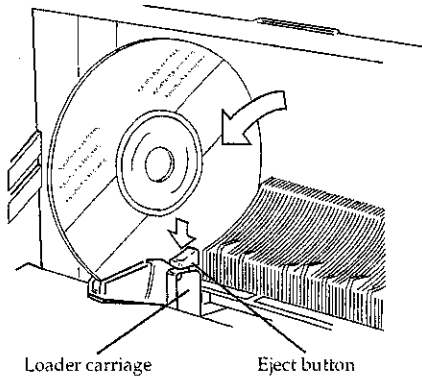

Setting/Removing discs

How to set discs

1 Pulling gently from both ends, open the front panel.

Caution

- Except when setting or removing discs, keep hands out of the changer while open. You could injure yourself if somehow entangled in the internal mechanism.
- Keep cassette tapes away from the magnetic latches.

2 Slide the loader carriage to the desired slot No. to insert a disc.

Note

Slot No. 0 (SINGLE) is reserved for single disc play. (See page 12.)

3 Set the disc on the loader and flip the loader upwards.

Caution

- Do not use 8 cm discs fitted with expander rings. Expander rings could damage the disc slots.
- Do not use cleaning discs or warped discs. All of these could damage your changer.
- Do not use discs with poorly attached labels or stickers. Adhesive protruding from peeled off stickers can cause the changer to malfunction.
- Do not put anything other than discs in the changer.
- Do not use irregular shape CDs (heart-shape, octagonal, etc.).

4 Close the front panel gently.

Note

If you leave the front panel open while a disc is in play, when the disc is over, the changer will stop.

How to remove discs

1. Open the front panel.
2. Slide the loader carriage to the slot you want.
3. Press the eject button on the loader carriage.

Special notes

You can set discs in the slots and remove them too, while playing discs.

- Do not set a disc in the slot of the disc being played (slot flashes). The disc in play is returned to its slot when finished. If two discs somehow jam in a slot, one or both could be damaged. When this happens, the message "TAKE OUT" will appear on the display. Remove the disc that doesn't belong in the slot and press the stop button.
- Do not open the front panel while the changer is changing discs.
- Sometimes the front panel cannot be opened while a disc is playing. It is a question of time. In such case, wait until you can open it.

Front panel controls

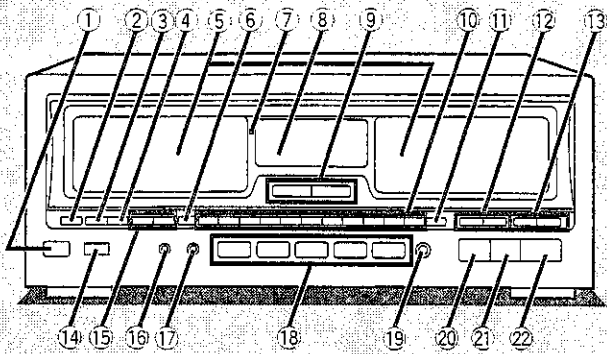

- ① Power "STANDBY \odot /ON" switch (POWER, STANDBY \odot /ON)
Press to switch the unit from on to standby mode or vice versa. In standby mode, the unit is still consuming a small amount of power.
- ② Single disc play button (SINGLE \blacktriangleright)
- ③ Direct programming button (DIRECT)
- ④ Programming button (PROGRAM)
- ⑤ Windows
- ⑥ Disc selector button (DISC)
- ⑦ "STANDBY" indicator (STANDBY)
When the unit is connected to the AC mains supply, this indicator lights up in standby mode and goes out when the unit is turned on.
- ⑧ Display
- ⑨ Disc skip buttons (DISC SKIP, $-$, $+$)
- ⑩ Numeric buttons (1-9, 0, ≥ 10)
- ⑪ Disc enter button (DISC ENTER)
- ⑫ Search/Text character select buttons (\blacktriangleleft , \blacktriangleright , SEARCH/CHARACTER)
- ⑬ Track skip/Text cursor removal buttons (\blacktriangleleft , \blacktriangleright , SKIP/CURSOR)
- ⑭ Remote control signal sensor (SENSOR)
- ⑮ Text search buttons (\blacktriangledown , \blacktriangle)
- ⑯ Text mode button (TEXT MODE)
- ⑰ Text edit button (TEXT EDIT)
- ⑱ Disc group buttons (DISC GROUPING PLAY, A, B, C, D, E)
- ⑲ Group enter button (GROUP ENTER)
- ⑳ Stop button (\blacksquare)
- ㉑ Pause button (||)
- ㉒ Play button (\blacktriangleright)

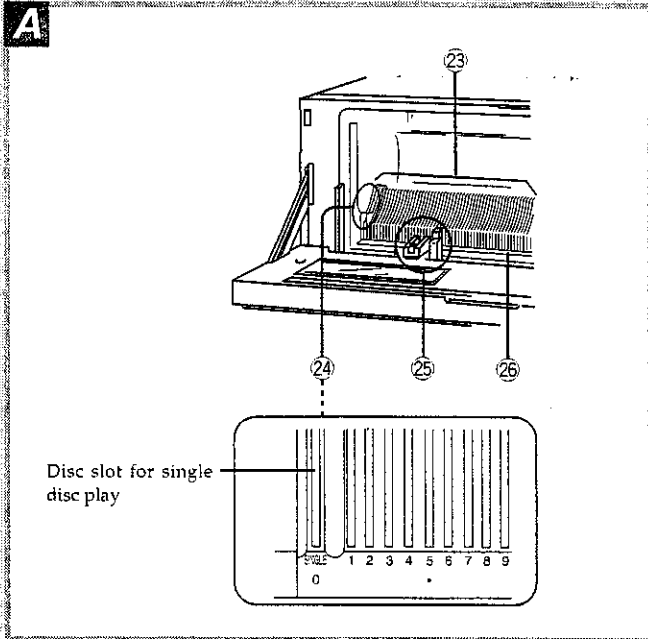

Disc slot section **A**

For an explanation on how to open the front panel, see page 8 "How to set discs".

- ㉓ Disc slots
- ㉔ Disc slot for single disc play (SINGLE)
- ㉕ Loader carriage
- ㉖ Slot numbers

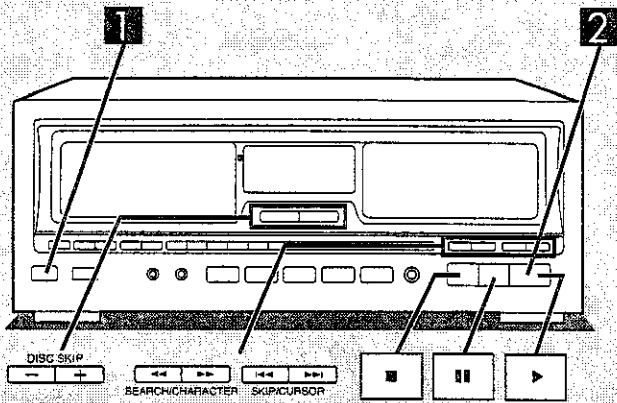

1

2

A

B

Basic operations

Sequential play

The changer plays all the tracks on all the discs in order and stops automatically when the last track on the last disc finishes playing.

Before starting, load your discs.

- 1 Press POWER.**
The unit will switch on.
Momentarily, the message "CHECKING DISCS" will appear on the display.
When it goes out, the last disc played will be displayed.

- 2 Press ▶.**
Play will begin.

The "▶" indication will illuminate.
The disc number, the track number and the elapsed play time will be displayed.
The disc number is the same as the slot number.

To search for the desired position	SEARCH/CHARACTER
To skip tracks	SKIP/CURSOR
To skip discs	DISC SKIP

(For detailed information concerning these buttons, please refer to pages 20—21.)

To stop play **A**

Press ■.
The disc number and the total number of tracks of the current disc will be displayed.

The total playing time displayed includes the silent sections between tracks. For this reason, it may be a few seconds longer than the playing time indicated on the disc.

When you open the front panel, the total number of tracks and the total playing time go out.

Press ▶ to re-start play.

Note
It takes roughly 3 seconds from the time you press ■ until the disc is returned to the slot.

To temporarily stop play **B**

Press ||.
Press ▶ to resume play.

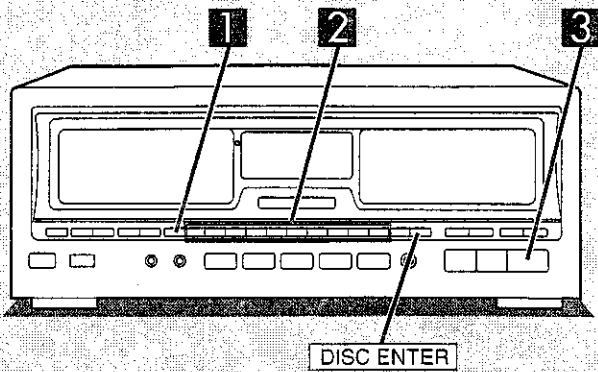
A**Basic operations****To directly access a specific disc****A****1** Press DISC.**2** [Within 7 seconds]**Select the disc you want with the numeric buttons.**

To select a disc from 1 to 9

For example: "6"

[6]

To select a disc from 10 to 110

For example: "19"

[1] → [9]

Push the buttons within 7 seconds of each other.

Note:

When selecting discs, the ≥10 button does not respond to touch.

3 [Within 7 seconds]**Press ▶.**

The changer will start playing the selected disc from the first track.

For your reference

- If you press DISC ENTER instead of ▶ to select a disc, the disc number will be displayed but play will not start automatically.
- When in the stop mode, if you select an empty slot, the message "NO DISC" will appear on the display.
- While a disc is playing, if you select an empty slot, the changer will automatically play the next disc available.
- If you select "0", the changer will switch to the single disc play mode.

To directly access a specific track**B**

After selecting a disc, select a track with the numeric buttons.

Press the numeric button(s) to select the track.

Play will begin from the selected track.

To select a track from 1 to 9

For example: "6"

[6]

To select a two-digit track number 10 or higher

For example: "19"

[≥10] → [1] → [9]

Push the buttons within 7 seconds of each other.

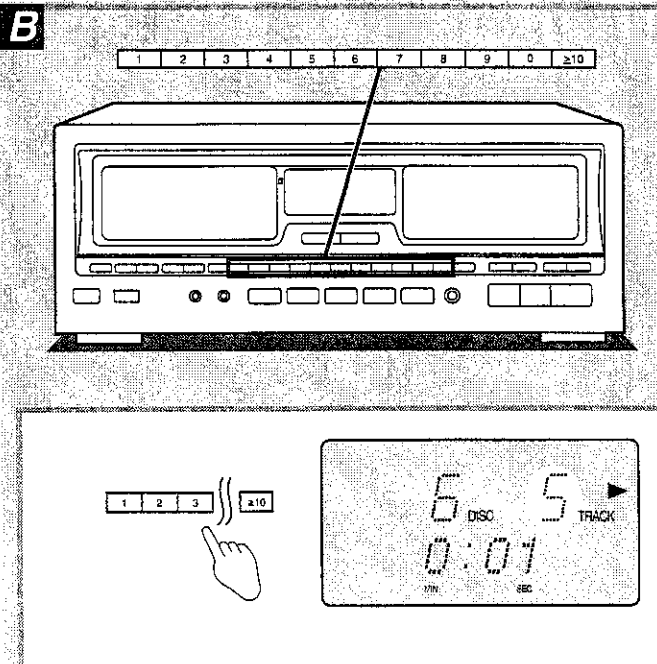
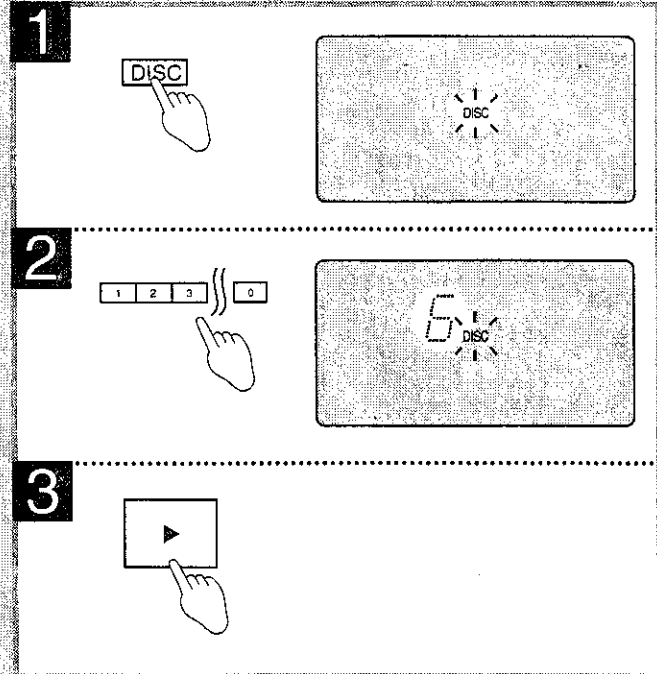

A

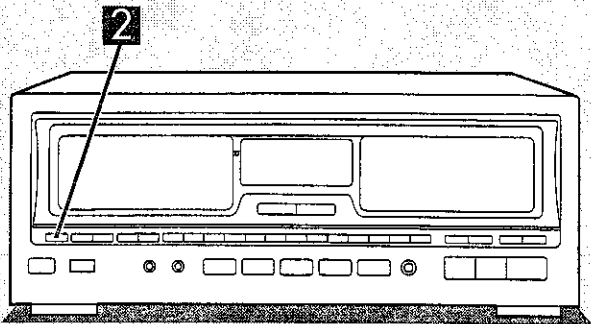

Single disc play

Single disc play is convenient when wanting to playback a specific disc right away, without going through the usual selection procedure, for example, to listen to a disc you just bought.

- 1** **Open the front panel, and set the disc in the slot No. 0.**
Face the disc label to the right and flip the loader upwards to set the disc.
- 2** **Close the front panel and press SINGLE** .

The changer plays all the tracks in order and stops automatically when the last track finishes playing.

To cancel single disc play mode

- Select another disc with the numeric buttons.
- Skip to another disc with DISK SKIP (- or +).
- Select a group.

ID scan function

(Only available from the remote control.)

This function is convenient to use when searching for a desired track.

The function will search from the beginning of the track for a loud section, and will play 10 seconds of the track centering around that point.

The order of scanning is the same as for play mode.

- 1** **Press ID SCAN.**
ID scan will start.
- 2** [When the desired track has been found]
Press .
The changer will play the track from the beginning.

To cancel ID scan

Press ID SCAN while this function is in operation.

The "ID" indicator will go out.

The changer will continue to play from the track being played.

1

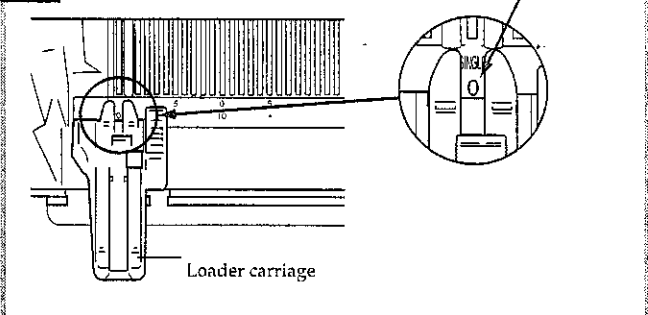

2



B

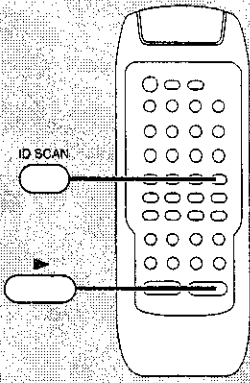

1



2

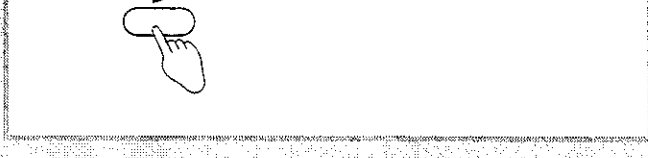

Disc grouping play

With disc grouping play, you can register discs under any of five available groups (A–E) and then play back only the discs in a specific group.

- The same disc can be registered in as many groups as you like.
- Each group can hold up to 110 discs.
- You can name each group.

To make groups

- 1 [During sequential play or while it is on stop]
Select a disc.

To select a disc from 1 to 9

For example: "6"

DISC → 6

To select disc from 10 to 110

For example: "19"

DISC → 1 → 9

Push the buttons within 7 seconds of each other.

Note

You cannot select slot No. 0.

For your reference

You can select discs with the DISC SKIP – and + buttons.

- 2 [Within 7 seconds]
Press GROUP ENTER.
If any groups have been registered already, their letters will light up.
- 3 [Within 7 seconds]
Press the DISC GROUPING PLAY button you want.
(This inputs the disc into the group.)

For example: To input a disc in group A.
Press [A].

- 4 **Repeat steps 1, 2 and 3 until you have completed all items.**

To cancel disc grouping play mode

[In the stop mode]

Press the DISC GROUPING PLAY button indicated on the display.

The group indication on the display will go out.

For your reference

The group contents will remain stored in memory even after the unit is switched off.

However, if the power cord is unplugged or the power supply is otherwise interrupted for an extended length of time, the contents will be erased from memory.

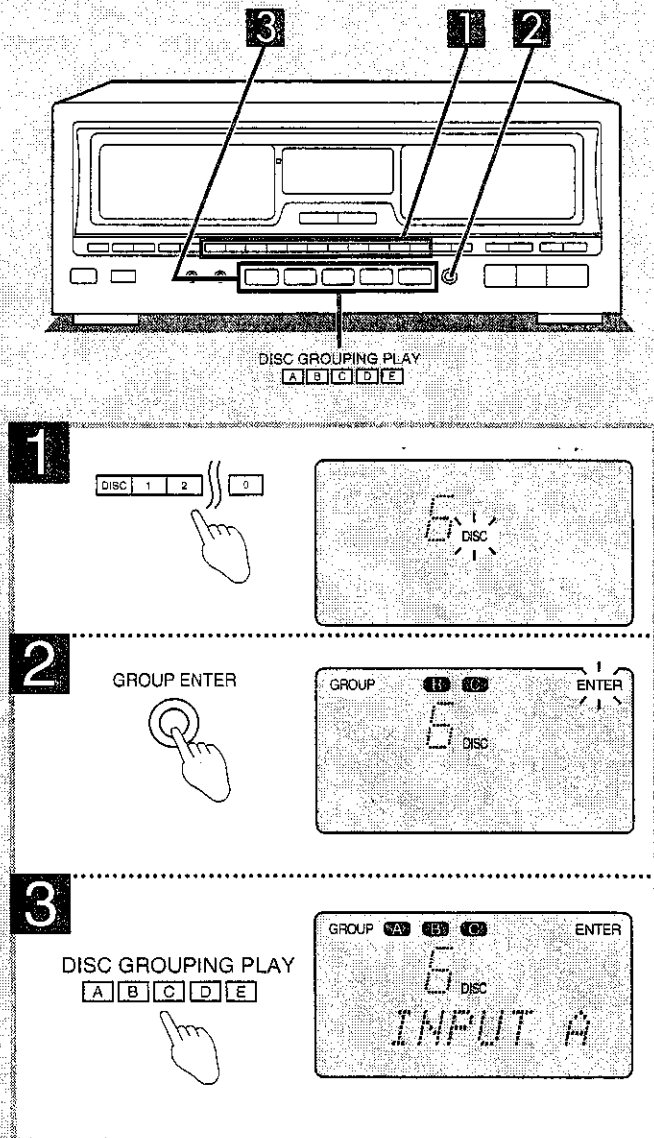

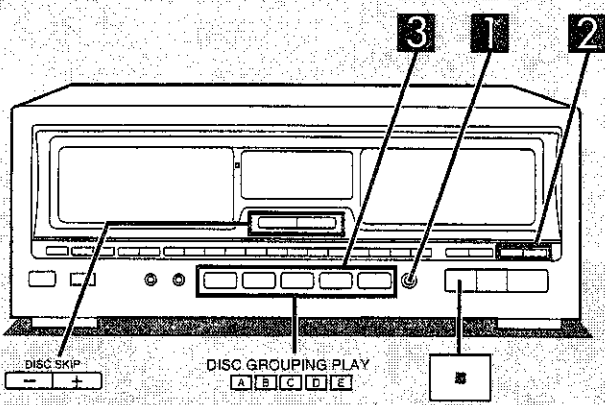

1 **GROUP ENTER**

2

3 **DISC GROUPING PLAY**

Disc grouping play

To name groups

You can name your groups. The changer has several preset names to choose from.

- 1** [During sequential play or while it is on stop]
Press GROUP ENTER.
 If any groups have been registered already, their letters will light up.
- 2** [Within 7 seconds]
Select the name you want with the SKIP/CURSOR <<< and >>> buttons.
 Names change in rotation as shown below, every time you press SKIP/CURSOR (<<< or >>>).

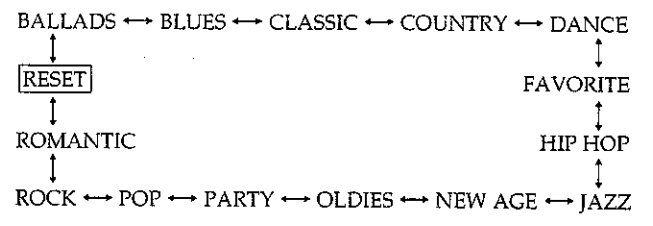

- 3** [Within 7 seconds]
Press the DISC GROUPING PLAY button for the group you want to name.

For example: To name group A
 Press [A].

- 4** **Repeat steps 1, 2 and 3 to name other groups.**

To cancel names

Select "RESET" in step 2 and then the name of the group you want to cancel in step 3. Thereafter, the group will appear as "GROUP ..." (A,B,C,D or E)".

To check what discs are in what groups

1. [During sequential play or while it is on stop]
 Press the DISC GROUPING PLAY button (A, B, C, D or E) you want and then press ■.
2. Press either DISC SKIP button (- or +).
 Every time you press DISC SKIP, the next disc number in order is displayed.

Note.

After checking, if you press the button of a group that is lit on the display, the disc grouping mode disengages.

Disc grouping play

To start play

Unless otherwise specified, the changer selects sequential play.

[During sequential play or while it is on stop]

Press the DISC GROUPING PLAY button of the group you want.

Disc grouping play will start.
For example: To hear group A
Press **A**.

Note:

- Unnamed groups will be displayed as "GROUP A, B, C, D or E".
- If you press the group button of a group which has no discs registered in it, the message "NO INPUT" will appear on the display.

To cancel discs from groups

1

Select a disc.

After pressing the DISC button, press the number of the disc that you want to cancel.

2

[Within 7 seconds]

Press GROUP ENTER.

3

[Within 7 seconds]

Press the DISC GROUPING PLAY button you want.

The selected group indication on the display will go out.

For example: To cancel disc No. 6 from group A.

Press **A**.

If the disc is registered in more than one group, you can cancel it from all groups in a single operation by pressing **■** in step 3 (in the stop mode).

A

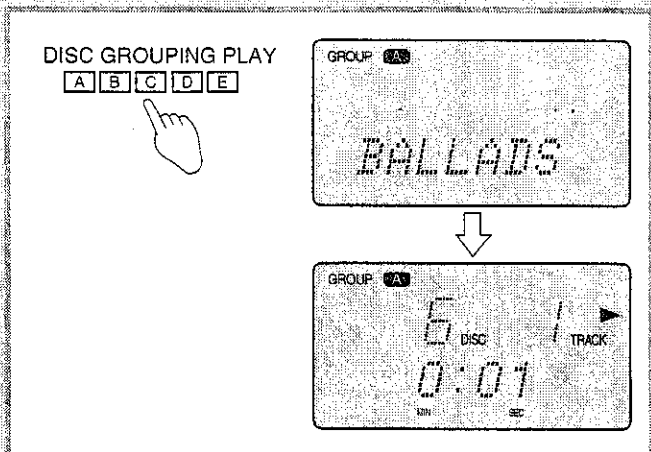
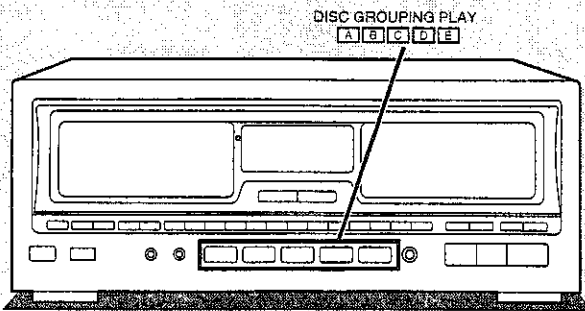

B

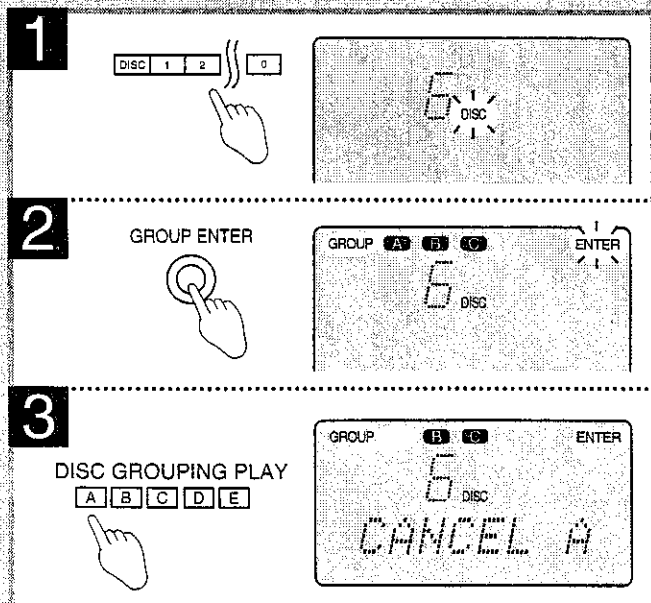
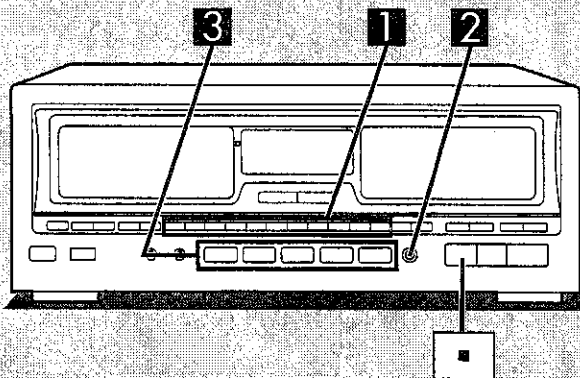

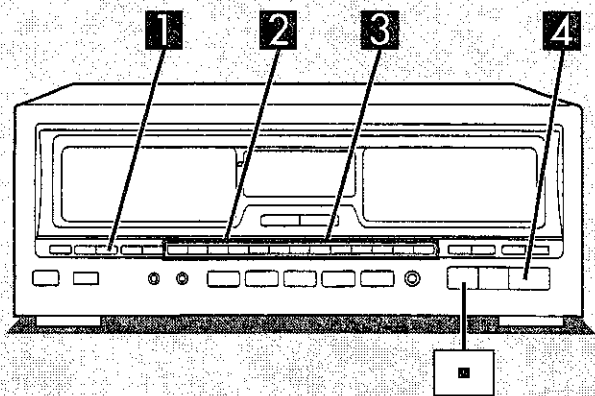

1 PROGRAM

2 DISC 1 2

3 1 2 3

4

A

Program play

Program play lets you playback your favorite tracks in the sequence you want to hear them. The program can hold up to 32 steps.

- 1** [In the stop mode]
Press **PROGRAM**.
- 2** Select the disc(s) you want with the numeric buttons.
For example: To select disc 3.
DISC → 3 → DISC ENTER
The "AL" indication shows that all the tracks on the disc are selected.
To program disc numbers only, repeat the above operation. (The count will increase by one for each operation.)
You can select slot No. 0.
- 3** Press the numeric button(s) to specify the track.

For example: To select track No. 20
≥10 → 2 → 0

To program another track from the same disc, simply specify the track No.

Repeat steps 2 and 3 until you have completed all entries.

If you attempt a 33rd selection, "PGM FULL" will appear on the display.

If you enter non-existing disc(s) or track(s), the corresponding indicator illuminates and the entry is included in the count. In the play mode, the changer will cancel the non-existing entry.

- 4** Press **▶** to start play.
To enter additional selections during play, repeat steps 2 and 3.

To clear all programmed contents **A**

[In the stop mode]
Press **■**.

Program play

To check programmed contents **A**

(Only available from the remote control.)

Press **RECALL**.

Each time you press RECALL, the display shows the programmed disc and track number in the sequence you have entered.

To clear a single item from the program **B**

(Only available from the remote control.)

[In the stop mode]

Press **CLEAR**.

Each time you press CLEAR, you will cancel the last entry in the order of your programmed selections.

To clear an entry in the middle of the program sequence, press RECALL repeatedly until the display shows the selection to be cleared, and then press CLEAR within three seconds after that.

To cancel the program mode **C**

[In the stop mode]

Press **PROGRAM**.

The changer will return to the sequential play mode.

The programmed contents will remain stored in memory until they are cleared, even after the program mode is canceled.

Therefore, after programming, it is possible to cancel the program mode and use another play mode and then hear the same program again at a later time.

In addition, if discs are changed, the program will be played using the new discs. If non-existing entries are found at this time, the changer will cancel them.

For your reference

The program will remain stored in memory even after the unit is switched off.

However, if the power cord is unplugged or the power supply is otherwise interrupted for an extended length of time, the contents will be erased from memory.

Special note on recording programs

The changer needs time to change the discs and find the tracks.

Consequently, it will take the changer slightly longer than the total track time to record everything. Exactly how much longer it will be will depend on the contents of the program.

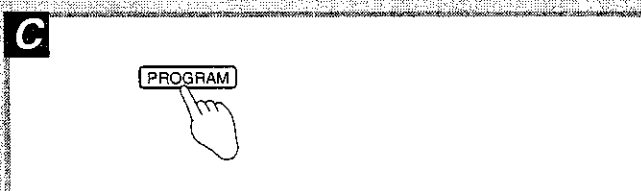
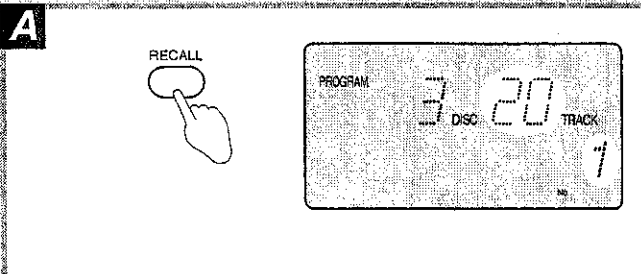
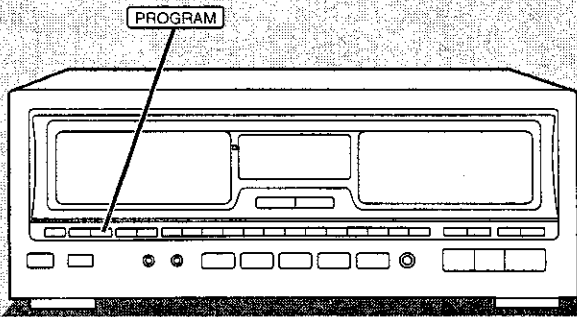
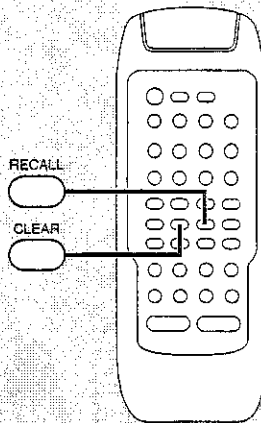

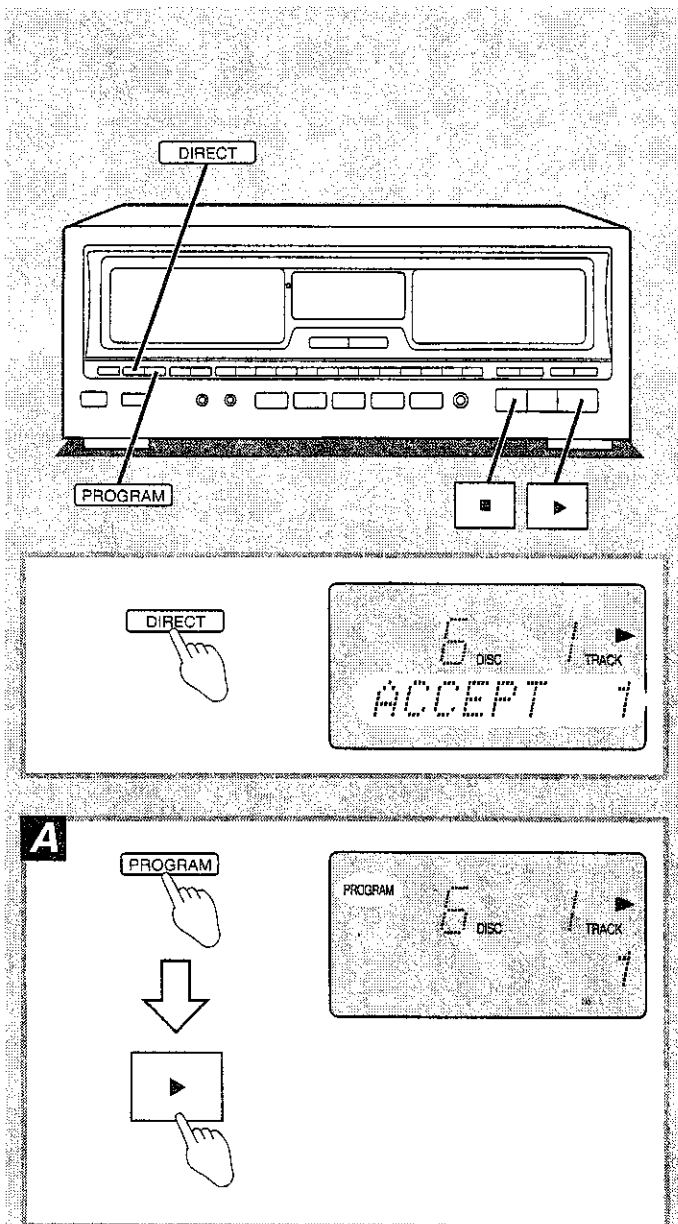

Direct programming

If, while listening to a certain track, you decide that you want to add that track to your program, you can with direct programming.

[While the track you want to program is playing]
Press DIRECT.

The current track will be added to the tail end of the program. When you make a program as explained under "Program play", and then perform the above procedure without clearing the program first, the selected track is added to the end of the program.

Note

- You cannot add to the program if already full, that is, if already 32 selections have been programmed. If you press DIRECT in such case, the message "PGM FULL" will appear on the display. Therefore, direct programming is possible only when 31 or less tracks have been programmed.
- During program play, the DIRECT button does not respond to touch.

To listen to programmed tracks **A**

[In the stop mode]

Press PROGRAM and check "PROGRAM" appears on the display, then press ►.

The program will start from the first track.

To check programmed contents.

(See page 17.)

To clear a single item from the program.

(See page 17.)

To clear all programmed contents.

[In the stop mode]

Press **■**.

Random play

(Only available from the remote control.)

The tracks will be played in random order. There are two types of random play as described below.

One disc random play **A**

The changer will play all tracks on the current disc in random order. Then, it will choose a new disc randomly, excluding the discs already played, and play all tracks on that disc in random order.

[In the stop or play mode]

Press RANDOM MODE so that the "1 DISC RANDOM" indicator illuminates.

Each time the button is pressed, the display will change in the following order: 1 DISC RANDOM → FULL RANDOM → (off).

The changer will stop automatically when all the tracks on all discs have been played once.

In the single disc play mode

Only tracks from the disc in slot No.0 are played, though played in random order.

Every time you press RANDOM MODE, the display switches between OFF and "RANDOM".

In the disc grouping play mode.

The changer randomly plays tracks only from discs included in the selected group.

Full random play **B**

The changer will play tracks from all of the discs at random. However, it may choose the same track twice. In a single pass, the changer can play up to 250 tracks.

[In the stop or play mode]

Press RANDOM MODE so that the "FULL RANDOM" indicator illuminates.

Each time the button is pressed, the display will change in the following order: 1 DISC RANDOM → FULL RANDOM → (off).

Once the changer has played the maximum 250 tracks, it stops automatically.

Note

The disc in slot No.0 will not be played.

In the disc grouping play mode.

The changer selects tracks randomly from all discs in the group but not from other groups.

To cancel random play mode

Press ■.

The "1 DISC (or FULL) RANDOM" indicator will go out.

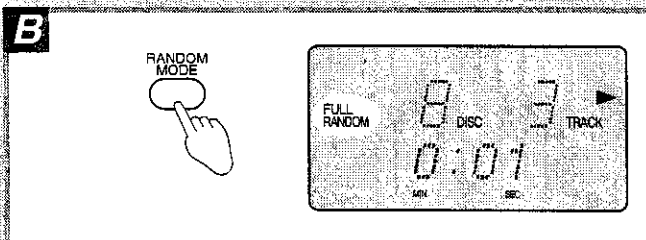
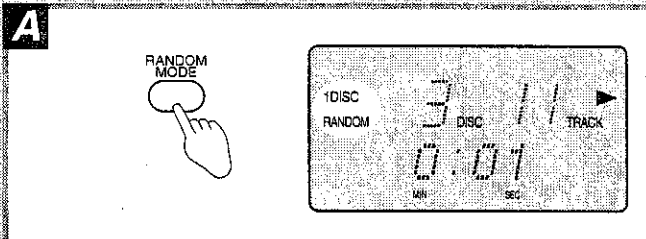
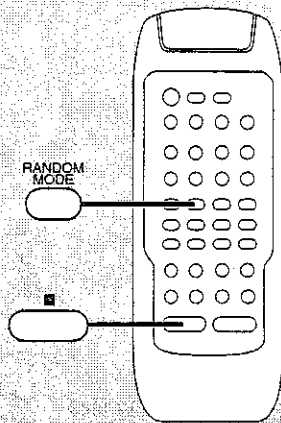

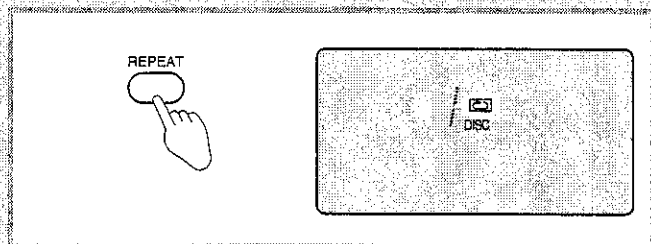
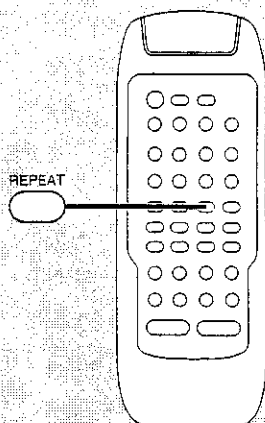
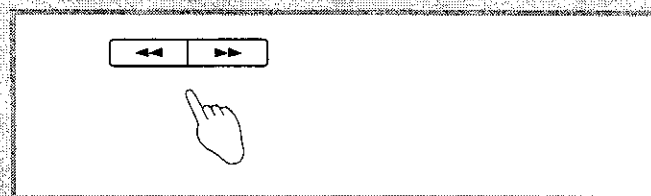
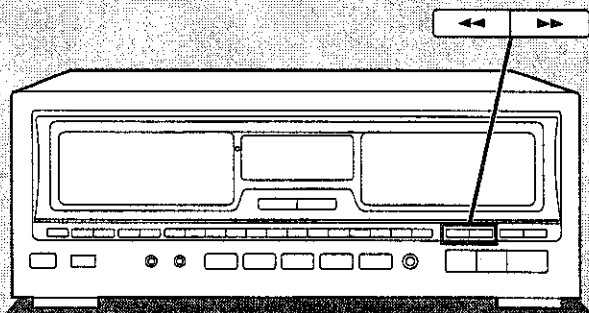
A**B**

Repeat function

(Only available from the remote control.)

Play will continue endlessly in accordance with the specific play mode selected.

[Before or during play]

Press REPEAT.

In the sequential play mode

All tracks of all discs will be played repeatedly.

In the single disc play mode

The changer will repeatedly play all tracks on the disc in slot No. 0.

In the program play mode

The changer plays only the programmed selections in the programmed sequence repeatedly.

In the one disc random play mode

When the changer has played all the tracks on the current disc in random order. Then, it will choose a new disc randomly, excluding the discs already played, and play continuously. The sequence differs each time.

In the full random play mode

Once the changer has played the maximum 250 tracks, it will select a new random sequence and will continue playing.

To repeat the same track over and over

1. Select the desired track using the program play procedure on page 16.
2. Press REPEAT to display "⊖".
3. Press ▶.

To cancel repeat mode

Press REPEAT again.

The "⊖" indicator will go out.

Search function

You can search rapidly forward or backward on a disc for specific sections.

[In the play or pause mode]

Press and hold SEARCH/CHARACTER (◀◀ or ▶▶).

◀◀ : You can search backward.

▶▶ : You can search forward.

Release the button when you reach the desired point.

The changer will return to the previous mode (play or pause).

In the sequential/disc grouping play mode

When the changer finishes searching the current disc, it starts searching the next one.

In the single disc play mode

You can search forward or backward only within the current disc.

In the program/random play mode

You can search forward or backward only within the current track.

Skip function

To skip discs

A

Use this function to skip discs when selecting a disc you wish to listen to.

You can use this function in stop, sequential play, one disc random play and disc grouping play modes.

Press either DISC SKIP (- or +) until you reach the desired disc.

-: Skips backwards to the preceding disc.

+: Skips forward to next disc.

Note:

- The changer skips over empty slots.
- This function does not work in the full disc random play mode or during program play.
- If you attempt to use this function during single disc play, the changer will cancel single disc play.

To skip tracks

B

Use this function to skip tracks when selecting a track which you wish to listen to.

Press either SKIP/CURSOR (◀◀ or ▶▶) until you reach the desired track.

◀◀: You can skip backward.

▶▶: You can skip forward.

In the sequential/single disc/disc grouping/program play mode

In the program play mode, you can skip from one track to another in the programmed sequence.

In any other mode, you can skip forward and backward within the current disc only.

◀◀: You can skip to the beginning of the track being played. If you press this button again quickly, you can skip to the beginning of the previous track.

▶▶: You can skip as many tracks as the number of times you press the button.

In the random play mode

◀◀: You can skip to the beginning of the current track.

▶▶: You can skip to the beginning of a next track in the random order the changer has selected.

You can also skip tracks when the changer is in the stop mode or pause mode.

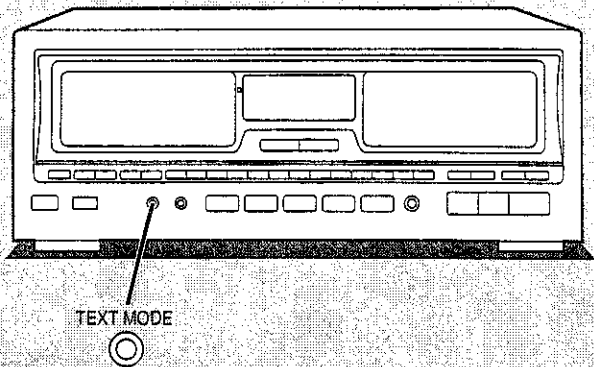

CD-TEXT function

CD-TEXT disc has text informations such as titles, artist's name, etc. The CD-TEXT function is not available until you play a piece of the disc and the changer reads the text informaion. The same applies when changing discs too.

If the CDs you have are without text information, you can input the information yourself for eventual display.

To change the text information on the display

Press **TEXT MODE**.

The display is changed in the following order:

In the stop mode

Album title → Artist name → Total playing time



In the play mode

Song title → Album title → Artist name → Time information



Note

- Text informations will each appear up to a maximum of 32 characters. During play, the recorded album title and/or song title is displayed in its entirety even if it is longer than 32 characters.
- Song titles are not displayed after a certain number of tracks if there are many tracks on the disc or if titles are exceptionally long.

CD-TEXT function

To search discs or tracks using text information (Text search)

There are 3 search modes: album title, artist name or song title.

Note

You cannot text search in program play / random play / ID scan mode.

To search discs (Album title search / Artist name search) **A**

- 1 Press **TEXT MODE** until the "ALBUM" or "ARTIST" indication appears on the display.

To search for a specific album title, call up "ALBUM" on the display. For a specific artist's name, make sure "ARTIST" is displayed.

- 2 Press **▼** or **▲** to select the desired disc.

Every time you press one of these buttons, the display changes in alphabetical order as follows.

▼: Titles or names progress in reverse order.

▲: Titles or names progress in regular order.

If, while the "SEARCH" indication is flashing on the display, you press the **TEXT MODE** button, the search mode changes but not the currently displayed disc.

Note

In the disc grouping play mode, the search is limited to the selected group and slot No. 0.

- 3 [Within 10 seconds]

Press **▶**.

The changer will start playing the selected disc.

To search tracks (Song title search) **B**

You can search through just the disc in play if you want.

- 1 [In the play mode]
Press **TEXT MODE** until the song title or time information appears on the display.

- 2 Press **▼** or **▲** to select the desired track.

Every time you press one of these buttons, the track number changes in order as follows.

▼: Numbers progress in reverse order.

▲: Numbers progress in regular order.

- 3 [Within 10 seconds]

Press **▶**.

The changer will start playing the selected track.

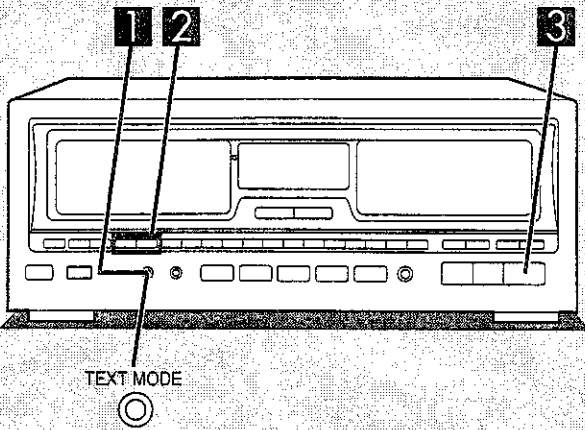

A

- 1 **TEXT MODE**
 The display shows: 8 DISC 8 TRACK, HAWAIIAN G, ALBUM.
- 2 The display shows: 6 DISC 9 TRACK, Instrument, ALBUM, SEARCH.
- 3 The display shows: 6 DISC 9 TRACK, Instrument, ALBUM, SEARCH.

B

- 1 **TEXT MODE**
 The display shows: 3 DISC 1 TRACK, Concerto N, SONG.
- 2 The display shows: 3 DISC 2 TRACK, Symphony N, SONG, SEARCH.
- 3 The display shows: 3 DISC 2 TRACK, Symphony N, SONG, SEARCH.

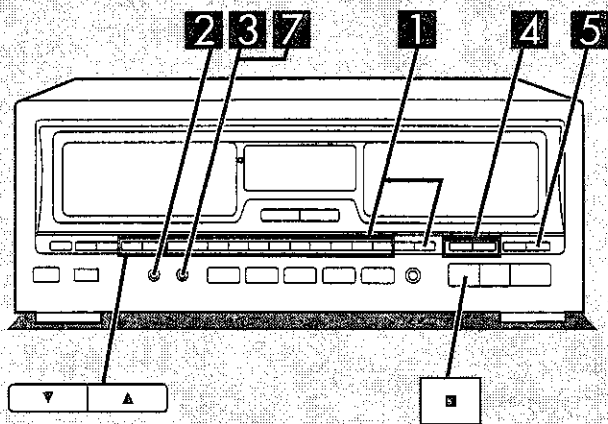

1 DISC 1 2 DISC ENTER

2 TEXT MODE

3 TEXT EDIT

4

5

7 TEXT EDIT

CD-TEXT function

To input text information (Text edit)

You can input the album title and artist's name for discs without text information. Each album title and artist's name can be up to 32 characters long.

- 1** [In the stop mode]
Select a disc.
 Example: To select slot No. 109
 DISC → 1 → 0 → 9 → DISC ENTER
- 2** **Press TEXT MODE** until the "ALBUM" or "ARTIST" indication appears on the display.
 To input an album title, call up "ALBUM" on the display. For an artist's name, make sure "ARTIST" is displayed.
- 3** **Press TEXT EDIT.**
 The cursor will start flashing when the changer is in the text edit mode.
- 4** **Press SEARCH/CHARACTER (◀◀ or ▶▶) to select the character.**
 If either SEARCH/CHARACTER button is pressed, the character changes.
 You can select from the following letters and symbols to input text.
 A B C D E F G H I J K L M N O P Q R S T U V W X Y Z
 a b c d e f g h i j k l m n o p q r s t u v w x y z
 0 1 2 3 4 5 6 7 8 9
 ! " # \$ % & ' () * + , - . / : ; < = > ? @ [\] ^ _ { | } ~ ` ¡ ¢ £ ¤ ¥ ¦ § ¨ © ª « ¬ ® ¯ ° ± ² ³ ´ µ ¶ · ¸ ¹ º » ¼ ½ ¾
 ¿ À Á Â Ã Ä Å Æ Ç È É Ê Ë Ì Í Î Ï Ð Ñ Ò Ó Ô Õ Ö × Ø Ù Ú Û Ü Ý Þ ß à á â ã ä å æ ç è é ê ë ì í î ï ð ñ ò ó ô õ ö ÷ ø ù ú û ý þ ÿ (space)
- 5** **Press SKIP/CURSOR (▶▶).**
 This enters the selected character and moves the cursor to the next character space.
- 6** **Repeat steps 4 and 5 to enter characters.**
- 7** **Press TEXT EDIT.**

Letters and symbols appearing on the display may vary slightly from the printed listing.
 As the ▼ and ▲ buttons are pressed, character type and case change in the following order:
 CAPITALS (A) ↔ small case (a) ↔ Numerals (1) ↔ Symbols (!)

Note

- It is not possible to add or overwrite text information on CD-TEXT discs.
- With discs not recorded with CD-TEXT, text information you input is linked to the specific slot No. when you make your input. Therefore, this information is deleted if you move the disc to another slot.

For your reference
 While in the text edit mode, you can cancel your input by pressing the STOP button.

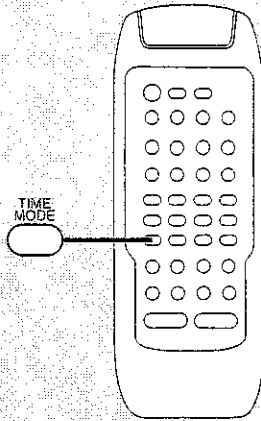

CD-TEXT function

To revise text information

Revisions are made in either of the following 2 ways.

• **To revise one character only**

1. Select the text listing where wanting to make your revision.
2. Press TEXT EDIT.
3. Press SKIP/CURSOR (◀◀ or ▶▶) until selecting the character you want change.
4. Press SEARCH/CHARACTER (◀◀ or ▶▶) to select the correct character.
5. Press TEXT EDIT.

• **To clear all characters**

1. Select the text listing you want to clear.
 2. Press TEXT EDIT.
 3. Press CLEAR of the remote control.
- Once the listing has been cleared, input the new listing.

Time mode selection

(Only available from the remote control.)

Various time information of the current disc can be accessed.

[In the play or pause mode]

Press TIME MODE.

The information will change each time you press the button.

- ① Track number and elapsed play time of the current track
- ② Total remaining time on the disc
- ③ Track number and remaining time of the current track
- ④ Total elapsed play time on the disc

In all play modes

When track number 21 or greater is playing, display ③ shows "----".

In the program/random play mode

The displayed information will alternate between displays ① and ③ each time the button is pressed.

When you stop playing and then start play again, the display will return the display ①.

Quick reference table for remote control operation

Basic operation	
	To turn OFF/ON the main unit POWER
	To select a specific disc DISC → →
	To select a specific track 1/A 2/B 3/C 4/D 5/E 6 ≥10 7 8 9 0 To select a track between 1 and 9: Press the corresponding number on the keypad. To select a two-digit track number or higher: First press ≥10, and then press the numbers for the two digits.
	To start play
	To stop play temporarily Press to resume play.
	To stop play

Single disc/random play	
	To play the disc in slot No.0 SINGLE ▶
	To start one disc/full random play RANDOM MODE Each time the button is pressed, the random mode will change in the following order:
	To stop random play This stops play and cancels random play at the same time.

Skip discs/skip tracks/repeat/search/ID scan function, Time mode selection	
	To skip discs - DISC SKIP +
	To skip tracks << SKIP >>
	To repeat play (Before or during play) REPEAT To cancel repeat mode. Press REPEAT again.
	To search for a desired place (In the play or pause mode) << SEARCH >>
	To start ID scan ID SCAN Press when the desired track has been found.
	To change time data shown in the display (In the play or pause mode) TIME MODE

Program play

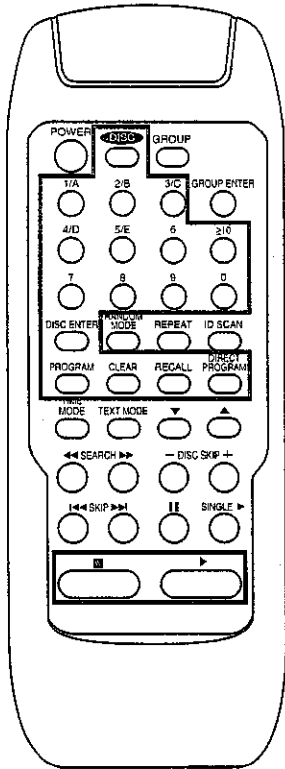

To start program play

- ① (In the stop mode)
PROGRAM
Select the program mode.

- ②
1/A 2/B 3/C
4/D 5/E 6
7 8 9 0
Select a disc.
DISC ENTER

- ③
1/A 2/B 3/C
4/D 5/E 6 ≥10
7 8 9 0
Select a track.
Repeat steps ② and ③ until you have completed all entries.

- ④
Start play.

To check programmed contents

RECALL
The selections entered are displayed one by one each time this button is pressed.

To clear a single item from the program

CLEAR
Only the selection which is currently displayed is cleared.

To clear all programmed contents

(In the stop mode)
DISC ENTER

To add the track currently being played to the program

(In the play mode)
DIRECT PROGRAM

CD-TEXT function

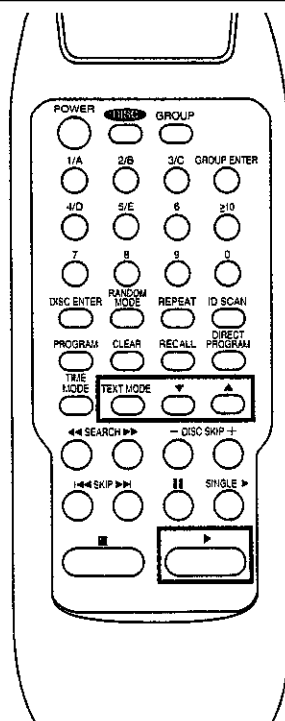

To change the text information of the display

TEXT MODE

To select a disc using album title or artist's name

- ① TEXT MODE
Select a "ALBUM" or "ARTIST" indication.

- ②
Select a disc.

- ③
Start play.

To select a track using song title

- ① (In the play mode)
TEXT MODE
Select a "SONG" indication or time information.

- ②
Select a track.

- ③
Start play.

Disc grouping play

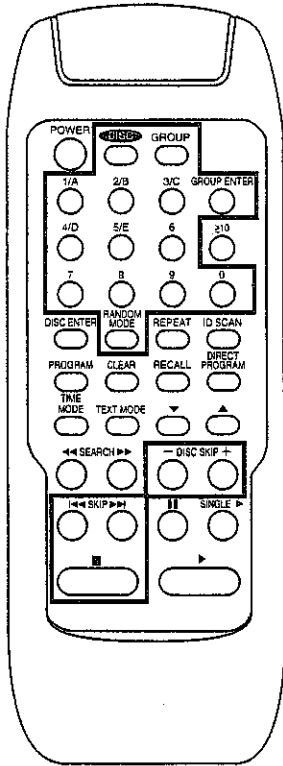

To group discs

① Select the disc number.

② Select the group enter mode.

③ Select a group. Repeat steps ①, ② and ③ until you have completed all items.

To cancel discs from groups

Perform above steps ① and ②, and then select the group you want to cancel in step ③.

To cancel a particular disc from all groups, press in step ③ above. (In the stop mode)

To name groups

① Select the group naming mode.

② Call up the group name you want on the display.

③ Select the group you want to name.

For sequential play within a given group

Select the group you want.

For random play within a given group

① Select the group you want.

② Select the random mode.

Concerning compact discs

With this changer, you can only play compact discs having this mark. However, do not use irregular shape CDs (heart-shape, octagonal, etc.). CDs of the sort can damage the unit.



Handling precautions

Handle CDs as shown on the left (A - D).

- If you are taking the disc from a cold to a warm environment, moisture may form on the disc. Wipe this off with a soft, dry, lint-free cloth before using the disc.
- Do not write on the label side with a ball-point pen or other writing instrument.
- Do not use record cleaning sprays, benzine, thinner, static electricity prevention liquids or any other solvent.
- Do not use discs with poorly attached labels or stickers. Adhesive protruding from peeled off stickers can cause the changer to malfunction.

Storage precautions

Be sure to store discs in their cases to protect them from dust, scratches, and warping.

Do not place or store discs in the following places:

- Locations exposed to direct sunlight
- Humid or dusty locations
- Locations directly exposed to a heat vent or heating appliance
- In the glove compartment or on the rear deck of an automobile

A How to remove CDs

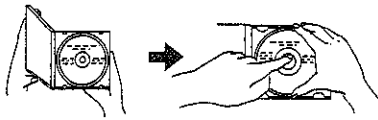

Press on center piece and lift from both sides.

B How to return CDs to their case

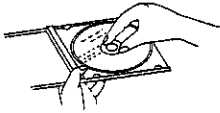

Face label upwards and press downward from above.

C How to hold CDs

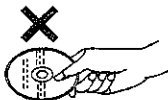
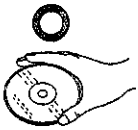

Do not touch the recorded surface

D How to clean CDs

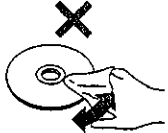
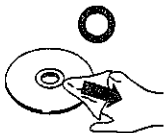

Wipe from inside outward.

Troubleshooting guide

Before requesting service for this unit, check the chart below for a possible cause of the problem you are experiencing. Some simple checks or a minor adjustment on your part may eliminate the problem and restore proper operation.

If you are in doubt about some of the check points, or if the remedies indicated in the chart do not solve the problem, refer to the directory of Authorized Service Centers (enclosed with this unit) to locate a convenient service center, or consult your Technics dealer for instructions.

Reference pages indicated in black circles. (For example: ③)

Problem	Probable cause(s)	Suggested remedy
Changer will not play.	A disc(s) or other foreign object(s) has fallen inside the changer.	• Open the front panel, and then remove the object.
	Moisture has collected in the changer.	• Allow the changer to dry out for about one hour before using it.
The disc in the changer does not play.	The disc label is facing left.	• Set the disc with the label facing right. (③)
	The disc is dirty.	• Wipe the disc with a soft cloth. (②)
	The disc is scratched.	• Replace the disc with a new one.
	The disc is warped.	
	The disc is not within specified standards.	
Play stops before changing to the next disc.	The front panel is open.	• Close the panel.
A certain music passage can't be played correctly.	The disc is dirty.	• Wipe the disc with a soft cloth. (②)
	The disc is scratched.	• Replace the disc with a new one.
There is noise from the tuner or disturbance on the TV screen.	Caused by high-frequency signals from this changer.	• Use the changer further away from the tuner or TV. • If the tuner or TV's antenna is the indoor type, use an outdoor one.
The error message "NO PGM" appears on the display, when program play is started.	Play was started without a track being programmed.	• Program a track. (④)
The error message "ERROR" appears on the display, and the changer stops operating.	The mechanism of the changer has been improperly adjusted.	• Turn the unit off and then back on again.
The error message "F-26" appears on the display and the changer stops operating.	The servo LSI has malfunctioned.	• Unplug the changer from its outlet, replug it in and turn the changer ON again.
The error message "TAKE OUT" appears on the display and the changer stops operating.	A disc has been put in the slot of the disc in play.	• Remove the disc whose number is displayed and press the stop button.
	Because of light or noise, the changer has detected a disc in the slot of the disc being played, even though it is empty.	• Check whether there is a disc in the displayed slot. With the front panel closed, hold down ■ for at least 4 seconds.
The changer does not respond correctly to remote commands.	The batteries have run out.	• Replace batteries with new ones.
	There is an obstruction between the remote control and the changer.	• Remove the obstruction.
	The batteries are inserted incorrectly. [The (+) and (-) polarities are reversed.]	• Reinsert batteries so that the polarities are correct.

Product service

Do not attempt to remove the cover(s) or repair the unit yourself. Refer servicing to qualified personnel only.

Product information

For product service, product information or assistance in product operation, refer to the servicer directory.

Having your unit serviced

Before bringing in your changer for service, be sure to remove all discs first.

If the disc in play doesn't return to its slot when you press , hold the button down for about 4 seconds. The disc should return to the slot.

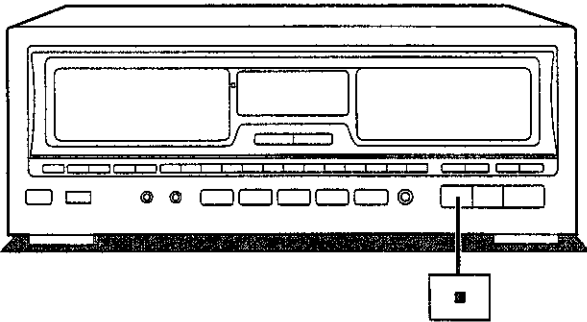

Technical specifications

AUDIO

No. of channels	2 (left and right, stereo)
Frequency response	2-20,000 Hz, ± 1 dB
Output voltage	2 V (at 0 dB)
Dynamic range	92 dB
S/N	100 dB
Harmonic distortion	0.007% (1 kHz, 0 dB)
Wow and flutter	Below measurable limit
DA converter	MASH (1 bit)
Output impedance	Approx. 1 k Ω
Load impedance	More than 10 k Ω

PICKUP

Wavelength	780 nm
------------	--------

GENERAL

Power supply	
For United Kingdom, Australia and N.Z.	AC 50 Hz, 230-240 V
For others	AC 50/60 Hz, 110V, 127V, 220V, 230-240 V
Power consumption	
For United Kingdom, Australia and N.Z.	14 W
For others	17 W
Dimensions (W×H×D)	430×170×387 mm
Weight	7.0 kg

Note: Specifications are subject to change without notice.
Weight and dimensions are approximate.

MASH is a trademark of NTT.

Disc index

It should be easier for you to remember what disc is in what slot and the group(s) it's in if you record everything in this table.

No	GROUP				DISC NAME
0	SINGLE				
1	A	B	C	D	
2	A	B	C	D	
3	A	B	C	D	
4	A	B	C	D	
5	A	B	C	D	
6	A	B	C	D	
7	A	B	C	D	
8	A	B	C	D	
9	A	B	C	D	
10	A	B	C	D	
11	A	B	C	D	
12	A	B	C	D	
13	A	B	C	D	
14	A	B	C	D	
15	A	B	C	D	
16	A	B	C	D	
17	A	B	C	D	
18	A	B	C	D	
19	A	B	C	D	
20	A	B	C	D	
21	A	B	C	D	
22	A	B	C	D	
23	A	B	C	D	
24	A	B	C	D	
25	A	B	C	D	
26	A	B	C	D	
27	A	B	C	D	
28	A	B	C	D	
29	A	B	C	D	
30	A	B	C	D	
31	A	B	C	D	
32	A	B	C	D	
33	A	B	C	D	
34	A	B	C	D	
35	A	B	C	D	
36	A	B	C	D	
37	A	B	C	D	
38	A	B	C	D	
39	A	B	C	D	
40	A	B	C	D	
41	A	B	C	D	
42	A	B	C	D	
43	A	B	C	D	
44	A	B	C	D	
45	A	B	C	D	
46	A	B	C	D	
47	A	B	C	D	
48	A	B	C	D	
49	A	B	C	D	
50	A	B	C	D	
51	A	B	C	D	
52	A	B	C	D	
53	A	B	C	D	
54	A	B	C	D	
55	A	B	C	D	

No	GROUP				DISC NAME
56	A	B	C	D	
57	A	B	C	D	
58	A	B	C	D	
59	A	B	C	D	
60	A	B	C	D	
61	A	B	C	D	
62	A	B	C	D	
63	A	B	C	D	
64	A	B	C	D	
65	A	B	C	D	
66	A	B	C	D	
67	A	B	C	D	
68	A	B	C	D	
69	A	B	C	D	
70	A	B	C	D	
71	A	B	C	D	
72	A	B	C	D	
73	A	B	C	D	
74	A	B	C	D	
75	A	B	C	D	
76	A	B	C	D	
77	A	B	C	D	
78	A	B	C	D	
79	A	B	C	D	
80	A	B	C	D	
81	A	B	C	D	
82	A	B	C	D	
83	A	B	C	D	
84	A	B	C	D	
85	A	B	C	D	
86	A	B	C	D	
87	A	B	C	D	
88	A	B	C	D	
89	A	B	C	D	
90	A	B	C	D	
91	A	B	C	D	
92	A	B	C	D	
93	A	B	C	D	
94	A	B	C	D	
95	A	B	C	D	
96	A	B	C	D	
97	A	B	C	D	
98	A	B	C	D	
99	A	B	C	D	
100	A	B	C	D	
101	A	B	C	D	
102	A	B	C	D	
103	A	B	C	D	
104	A	B	C	D	
105	A	B	C	D	
106	A	B	C	D	
107	A	B	C	D	
108	A	B	C	D	
109	A	B	C	D	
110	A	B	C	D	

Write your group names here.

GROUP	GROUP NAME
A	
B	
C	
D	
E	

Matsushita Electric Industrial Co., Ltd.
Central P.O. Box 288, Osaka 530-91, Japan